

HP/Agilent 8922 GSM HSCSD Test System Option #K09

Supplementary User's Guide

**Systems Covered
HP/Agilent 8922 P Multi-Band Test System**



Manufacturing Part Number: 08922-90218

© Copyright February 1999 Agilent Technologies

Warranty

This Agilent Technologies instrument product is warranted against defects in material and workmanship for a period of one year from date of shipment. During the warranty period, Agilent Technologies will at its option, either repair or replace products which prove to be defective

For warranty service or repair, this product must be returned to a service facility designated by Agilent Technologies. Buyer shall prepay shipping charges to Agilent Technologies and Agilent Technologies shall pay shipping charges, duties, and taxes for products returned to Agilent Technologies from another country

Agilent Technologies warrants that its software and firmware designated by Agilent Technologies for use with an instrument will execute its programming instructions when properly installed on that instrument. Agilent Technologies does not warrant that the operation of the instrument, or software, or firmware will be uninterrupted or error free.

Limitation of Warranty

The foregoing warranty shall not apply to defects resulting from improper or inadequate maintenance by Buyer, Buyer-supplied software or interfacing, unauthorized modification or misuse, operation outside of the environmental specifications for the product, or improper site preparation or maintenance.

NO OTHER WARRANTY IS EXPRESSED OR IMPLIED. AGILENT TECHNOLOGIES SPECIFICALLY DISCLAIMS THE IMPLIED WARRANTIES OF MERCHANTABILITY AND FITNESS FOR A PARTICULAR PURPOSE.

Limitation of Remedies and Liability

THE REMEDIES PROVIDED HEREIN ARE BUYER'S SOLE AND EXCLUSIVE REMEDIES. AGILENT TECHNOLOGIES SHALL NOT BE LIABLE FOR ANY DIRECT, INDIRECT, SPECIAL, INCIDENTAL, OR CONSEQUENTIAL DAMAGES, WHETHER BASED ON CONTRACT, TORT, OR ANY OTHER LEGAL THEORY.

Responsibilities of the Customer

The customer shall provide;

- Access to the products during the specified periods of coverage to perform maintenance.
- Adequate working space around the products for servicing by Agilent Technologies personnel.
- Access to and use of all information and facilities determined necessary by Agilent Technologies to service and/or maintain the products. (In so far as these items may contain proprietary or classified information, the customer shall assume full responsibility for safeguarding and protection from wrongful use.)
- Routine operator maintenance and cleaning as specified in the Agilent Technologies Operating and Service Manuals.
- Consumables such as paper, disks, magnetic tapes, ribbons, inks, pens, gases, solvents, lamps, filters, fuses, seals, etc.

Certification

Agilent Technologies certifies that this product met its published specifications at the time of shipment from the factory. Agilent Technologies further certifies that its calibration measurements are

traceable to the United States National Bureau of Standards and Technology, to the extent allowed by the Bureau's calibration facility, and to the calibration facilities of other International Standards Organization members.

Assistance

Product maintenance agreements and other customer assistance agreements are available for Agilent Technologies products.

For any assistance, contact your local Agilent Technologies Sales and Service Office. For a list of contact information, "Sales and Service Offices" on page 72.

Notices

The information contained in this document is subject to change without notice. AGILENT TECHNOLOGIES MAKES NO WARRANTY OF ANY KIND WITH REGARD TO THIS MATERIAL, INCLUDING, BUT NOT LIMITED TO, THE IMPLIED WARRANTIES OF MERCHANTABILITY AND FITNESS FOR A PARTICULAR PURPOSE. Agilent Technologies shall not be liable for errors contained herein or for incidental or consequential damages in connection with the furnishing, performance or use of this material.

Agilent Technologies assumes no responsibility for the use or reliability of its software on equipment that is not furnished by Agilent Technologies.

Restricted Rights Legend

If Software is for use in the performance of a U.S. Government prime contract or subcontract, Software is delivered and licensed as "Commercial computer software" as defined in DFAR 252.227-7014 (June 1995), or as a "commercial item" as defined in FAR 2.101(a) or as

"restricted computer software" as defined in FAR 52.227-19 (June 1987) or any equivalent agency regulation or contract clause. Use, duplication or disclosure of Software is subject to Agilent Technologies' standard commercial license terms and non-DOD Departments and Agencies of the U.S. Government will receive no greater than Restricted Rights as defined in FAR 52.227-19(c)(1-2) (June 1987). U.S. Government users will receive no greater than Limited Rights as defined in FAR 52.227-14 (June 1987) or DFAR 252.227-7015 (b)(2) (November 1995), as applicable in any technical data. Copyright 2000 Agilent Technologies Inc. All Rights Reserved.

Statement of Compliance

This product conforms to EN61010-1(1993) / IEC 1010-1(1990) +A1(1992) +A2(1994) /CSA C22.2 No. 1010.1(1993) Safety requirements for Electrical Equipment for Measurement, Control and Laboratory Use, and has been supplied in a safe condition. The instruction documentation contains information and warnings which must be followed by the user to ensure safe operation and to maintain the instrument in a safe condition.

Electromagnetic Compatibility (EMC) Information

This product has been designed to meet the protection requirements of the European Communities Electromagnetic Compatibility (EMC) directive:

- EN55011:1991 (Group 1, Class A)
- EN50082-1:1992
- IEC 1000-4-2 (1995) ESD
- IEC 1000-4-3 (1995) Radiated Susceptibility
- IEC 1000-4-4 (1995) EFT

In order to preserve the EMC performance of this product, any cable which becomes worn or damaged, must be replaced with the same type and specification.

Sound Emission

Manufacturer's Declaration

This statement is provided to comply with the requirements of the German Sound Emission Directive, from 18 January 1991.

This product has a sound pressure emission (at the operator position) < 70 dB(A).

- Sound Pressure $L_p < 70$ dB(A).
- At Operator Position.
- Normal Operation.
- According to ISO 7779:1988/EN 27779:1991 (Type Test).

Herstellerbescheinigung

Diese Information steht im Zusammenhang mit den Anforderungen der Maschinenlärminformationsverordnung vom 18 Januar 1991.

- Schalldruckpegel $L_p < 70$ dB(A).
- Am Arbeitsplatz.
- Normaler Betrieb.
- Nach ISO 7779:1988/EN 27779:1991 (Typprüfung).

Safety Information

The following general safety precautions must be observed during all phases of operation, service, and repair of this instrument. Failure to comply with these precautions or with specific warnings elsewhere in this manual violates safety standards of design, manufacture, and

intended use of the instrument. Agilent Technologies assumes no liability for the customer's failure to comply with these requirements.

WARNING

This is a Safety Class I instrument (provided with a protective earthing ground, incorporated in the power cord). The mains plug shall only be inserted in a socket outlet provided with a protective earth contact. Any interruption of the protective conductor inside or outside of the instrument is likely to make the instrument dangerous. Intentional interruption is prohibited.

DO NOT operate the product in an explosive atmosphere or in the presence of flammable gasses or fumes.

DO NOT use repaired fuses or short-circuited fuseholders: For continued protection against fire, replace the line fuse(s) only with fuse(s) of the same voltage and current rating and type.

DO NOT perform procedures involving cover or shield removal unless you are qualified to do so: Operating personnel must not remove equipment covers or shields. Procedures involving the removal of covers and shields are for use by service-trained personnel only.







DO NOT service or adjust alone: Under certain conditions, dangerous voltages may exist even with the equipment switched off. To avoid dangerous electrical shock, service personnel must not attempt internal service or adjustment unless another person, capable of rendering first aid and resuscitation, is present.

DO NOT operate damaged equipment: Whenever it is possible that the safety protection features built into this product have been impaired, either through physical damage, excessive moisture, or any other reason, REMOVE POWER and do not use the product until safe operation can be verified by service-trained personnel. If necessary, return the product to an Agilent Technologies Sales and Service Office for service and repair to ensure the safety features are maintained.

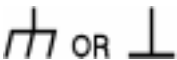

DO NOT substitute parts or modify equipment: Because of the danger of introducing additional hazards, do not install substitute parts or perform any unauthorized modification to the product. Return the product to an Agilent Technologies Sales and Service Office for service and repair to ensure the safety features are maintained.

Safety Symbols

The following symbols on the instrument and in the manual indicate precautions which must be taken to maintain safe operation of the instrument

Safety Symbols	
	The Instruction Documentation Symbol. The product is marked with this symbol when it is necessary for the user to refer to the instructions in the supplied documentation.
	Indicates the field wiring terminal that must be connected to earth ground before operating the equipment - protects against electrical shock in case of fault.
	Frame or chassis ground terminal - typically connects to the equipment's metal frame.
	Alternating current (AC)
	Direct current (DC)
	Indicates hazardous voltages.
WARNING	Warning denotes a hazard. It calls attention to a procedure, which if not correctly performed or adhered to could result in injury or loss of life. Do not proceed beyond a warning note until the indicated conditions are fully understood and met.
CAUTION	Caution denotes a hazard. It calls attention to a procedure, which if not correctly performed or adhered to could result in damage to or destruction of the instrument. Do not proceed beyond a warning note until the indicated conditions are fully understood and met.

Safety Symbols

	The CE mark shows that the product complies with all relevant European Legal Directives.
ISM 1-A	This is a symbol of an Industrial, Scientific, and Medical Group 1 Class A product.
	The CSA mark is a registered trademark of the Canadian Standards Association, and indicates compliance to the standards defined by them.
 EN 60825 1981	Indicates that a laser is fitted. The user must refer to the manual for specific Warning or Caution information to avoid personal injury or damage to the product.

About this Guide

Overview

This User's Guide is a supplement to the manuals currently supplied with the HP/Agilent 8922 GSM Test Sets. The information contained in this User's Guide is only relevant to the additional features of the HP/Agilent 8922 GSM HSCSD Test System. For more information on the HP/Agilent 8922 and HP/Agilent83220, refer the following Guides;

- *Agilent 8922MS User's Guide*
- *Agilent 8922MS Programming Reference Guide*
- *Agilent 83220A/E User's Guide*
- Agilent Multi-Band Test System Supplementary User's Guide

User's Guide - Abbreviations

For clarity, and unless otherwise stated, the following abbreviations will be used:

HP/Agilent 8922P/X Option 010: this will be abbreviated to HP/Agilent 8922

HP/Agilent 83220A/E Option 010: this will be abbreviated to HP/Agilent 83220

Contents

1. Understanding the HP/Agilent 8922 GSM HSCSD Test System	
Getting an overview of the HP/Agilent 8922 GSM HSCSD Test System	2
Features	4
2. Setting up the HP/Agilent 8922 GSM HSCSD Test System	
Before you start	6
Checking the HP/Agilent 8922 Requirements for HSCSD	7
Making the front panel connections	8
Making the rear panel connections	9
Enabling the HSCSD functionality	11
Calibrating the overall system	14
3. Manual operation	
Configuring the system	16
Establishing a call	18
Making measurements	19
Choosing which timeslot to measure	19
Measuring BER	19
Changing band and making measurements in the E-GSM900 and DCS 1800 bands	19
Changing power levels, timeslot and channels	20
Ending a call	21
4. Screens	
Config screen	24
1. Instrument type	24
2. Slave address	26

Contents

HSCSD screen	27
1. Master downlink amplitude	27
2. Slave offset	28
3. Master channel	28
4. Master timeslot	30
5. Slave timeslot	30
6. Call Type	31
7. Data rate	32
8. Measure	32
9. Master Tx level	33
10. Master input level	34
11. Master mode	35
12. Slave Tx level	35
13. Slave input level	36
14. Slave control	37
15. Mobile reports	38
16. Peak power display	38
17. To Screen menu	38
Fast BER Screen	39
Loopback	40
5. Remote operation	
Introduction	42
Configure Subsystem GPIB Commands	43
CONFigure:INSTrument[:TYPE]	43
Display Subsystem GPIB Commands	44
DISPlay:SCREen HSCSD	44
HSCSD Subsystem GPIB Commands	45
HSCSD:MASter:TCH:ARFCn	48
HSCSD:MASter:STATus:TCH:TSLot	49

Contents

HSCSD:MASTER:DOWNlink:AMPLitude	50
HSCSD:MASTER:TCH:TLEVel	51
HSCSD:MASTER:UPLink:AMPLitude	52
HSCSD:MASTER:UPLink:AMPLitude:CONTRol	53
HSCSD:MASTER:CALL:TYPE	54
HSCSD:MASTER:CALL:RATE	55
HSCSD:SLAVE:STATus:SYNC	56
HSCSD:SLAVE:STATus:TCH:TSLot?	57
HSCSD:SLAVE:DOWNlink:AMPLitude:OFFSet.	58
HSCSD:SLAVE:TCH:TLEVel	59
HSCSD:SLAVE:UPLink:AMPLitude	60
HSCSD:SLAVE:UPLink:AMPLitude:CONTRol	61
Remote operating procedures	62
Configuring the system	62
Establishing a call	63
Making measurements.	63
Changing channels, timeslot and power levels.	64
Ending a call.	65
Example code showing a dual-band handover from E-GSM to DCS . . .	66
6. Returning equipment for repair	
Return Procedure.	70
Sales and Service Offices.	72
Asia Pacific:	72
Japan:	72
Australia/New Zealand:	72
Canada:	73
Europe:	73
Latin America:	73
United States:	73

Contents

A. Upgrading the HOP Controller ROM and Firmware

Upgrading the Hop Controller ROM.....	76
Upgrading the firmware	80

1 Understanding the HP/Agilent 8922 GSM HSCSD Test System

This chapter provides an overview of the HP/Agilent 8922 GSM HSCSD Test System.

Getting an overview of the HP/Agilent 8922 GSM HSCSD Test System

The HP/Agilent 8922 GSM HSCSD Test System option #K09, is ideal for mobile testing in research and development, and can also be used in manufacturing test applications. The HP/Agilent 8922 GSM HSCSD Test System option #K09 consists of two HP/Agilent 8922 P systems connected together in a master/slave setup as shown below. A single unit version of the HP/Agilent 8922 GSM HSCSD Test System (option #K17), ideal for manufacturing and service test, is also available.

Figure 1-1 **The HP/Agilent 8922 GSM HSCSD Test System, option #K09**

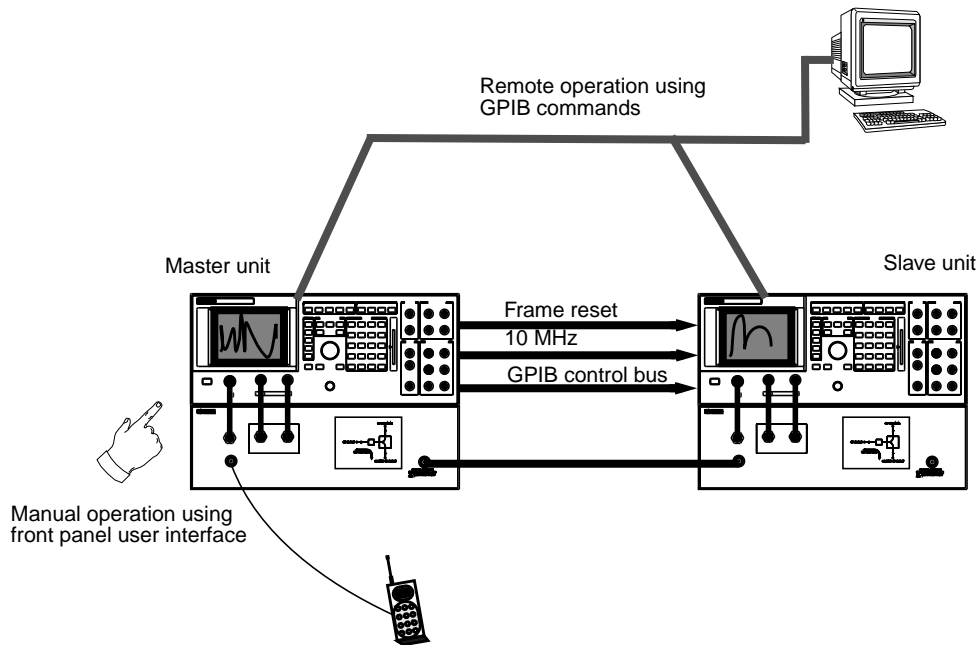

Understanding the HP/Agilent 8922 GSM HSCSD Test System
Getting an overview of the HP/Agilent 8922 GSM HSCSD Test System

The HP/Agilent 8922 GSM HSCSD Test System is used either as a stand-alone instrument controlled manually via the front panel user interface, or as part of an automated test system controlled remotely over the GPIB bus using a PC or workstation. Note that manual and remote operation are not possible simultaneously.

The HP/Agilent 8922 GSM HSCSD Test System provides one configuration consisting of two uplink and two downlink timeslots (2x2) or two downlink and one uplink timeslot (2x1). Data rates of 9.6 and 14.4 kbit/s on each timeslot are supported. The timeslots used are always adjacent, with the master channel in the first of these slots. You are able to independently change the uplink and downlink power levels on the two downlink timeslots and make measurements on either timeslot as required.

Note that the system does not perform any data channel decoding on the uplinks and only provides pre-coded data on the downlinks. The current system only allows transparent data links, which means that the RLP data layer is not supported.

Operating modes The master unit operates in **Active Cell Mode** and is responsible for all protocol messages. The mobile must therefore camp to the master unit, establish the call to it and receive channel assignment commands from it etc.

The slave unit operates in **Test Mode**. It generates a second downlink TCH and can analyze a second uplink TCH (if it exists). The slave unit remains in synchronization with the master unit at all times.

The BCH of the slave unit includes information to prevent the mobile from camping to the slave, thus ensuring that the mobile camps to the master unit. To discourage unsynchronised operation, the slave unit does not generate a downlink TCH unless it has received a reset signal from the master unit.

Features

The HP/Agilent 8922 GSM HSCSD Test System supports the following features. The full range of features available in speech mode is maintained.

- Support of fully variable power level of each active timeslot on the downlink. This provides complete freedom to control the amplitude of the downlinks.
- Support of fully independent power control by protocol of each active timeslot on the uplink. This allows you to independently set the Tx level of each timeslot.
- Transmit SACCH in each active slot on the downlink (call maintenance + power control) according to ETSI multi-frame structure. This provides a SACCH frame in the correct position on both the downlink TCHs.
- All existing measurement functionality and performance maintained and performed on any slot independently. You can select either uplink slot to measure, either by selecting one instrument or via a field on the user interface.
- Support of protocol to set up a 2x2 or 2x1, 9.6 or 14.4 kbps timeslot uplink/downlink data channel (both Mobile Originated and Mobile Terminated). The existing HP/Agilent 8922P functionality to originate or receive a call is still available.
- Support of burst-by-burst (fast) BER test on both 14.4 kbps timeslot data channels simultaneously. The existing bit error test functionality of the HP/Agilent 8922P is available in speech mode only.
- You can select any timeslot for the master channel in the range 2 through 5. The slave timeslot is always the following slot. Any ARFCN can be used in any of the currently supported bands (GSM900, E-GSM, DCS1800 and PCS1900).
- Dual-band assignment supported. The existing HP/Agilent 8922P functionality to perform a dual-band assignment is maintained.
- All 2x2 HSCSD calls are in transparent mode and all 2x1 calls are in non-transparent mode.

2 **Setting up the HP/Agilent 8922 GSM HSCSD Test System**

This chapter describes how to connect and set up the HP/Agilent 8922 GSM HSCSD Test System.

Before you start

WARNING

The HP/Agilent 8922 is a Safety Class 1 product (provided with a protective earth terminal). A safety earth ground must be provided from the mains power source to the product input wiring terminals, power cord, or supplied power cord set. Whenever it is likely that the protection has been impaired, the HP/Agilent 8922 GSM HSCSD Test System must be made inoperative and be secured against any unintended operation.

WARNING

If the HP/Agilent 8922 is to be energized via an external autotransformer for voltage reduction, make sure that the common terminal is connected to the neutral pole of the power source.

Checking the HP/Agilent 8922 Requirements for HSCSD

To run the HSCSD functionality you need two HP/Agilent 8922 P systems (one acting as a master and one acting as a slave). Each system must be running firmware version C.01.06 or later and contain a HOP Controller ROM with a revision number of 19980730 or greater.

To check which version of firmware is running on the HP/Agilent 8922, go to the Config screen.

To check which version of HOP Controller ROM is installed in the HP/Agilent 8922, go to the Service screen and select the `hop_revision` latch.

For details on how to upgrade the HP/Agilent 8922's HOP Controller ROM and firmware, see Appendix A , "Upgrading the HOP Controller ROM and Firmware," on page 75.

Making the front panel connections

Before you connect the two HP/Agilent 8922 P systems together to form the HP/Agilent 8922 GSM HSCSD Test System, ensure that both HP/Agilent 8922 P systems are connected and calibrated as described in the *HP/Agilent 8922 Multi-Band Test System Supplementary User's Guide*. For details on the HP/Agilent 8922P front panel connections, see the *HP 8922 Multi-Band Test System Supplementary User's Guide*.

The RF flow must be combined and split between the two HP/Agilent 8922P systems. This is done by connecting the supplied RF link cable (08922-61185) between the Coupled RF Port on the dual band HP/Agilent 83220 of the master unit and the GSM/DCS/PCS RF In/Out port on the HP/Agilent 83220 of the slave unit.

Figure 2-1 Front panel connections

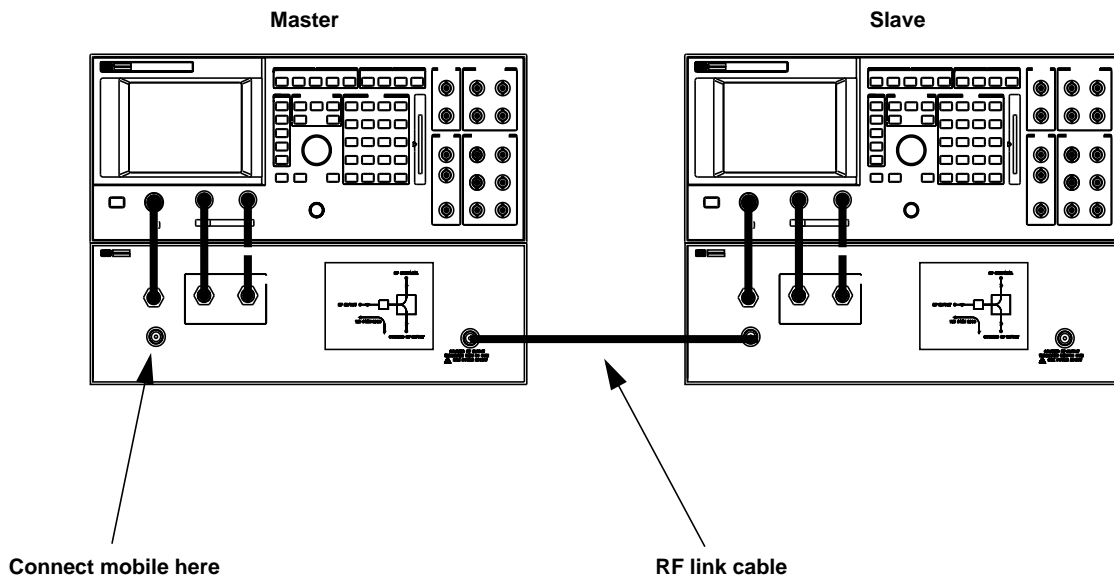

Making the rear panel connections

Before connecting the two HP/Agilent 8922 P systems to form the HP/Agilent 8922 GSM HSCSD Test System, ensure that both HP/Agilent 8922 P systems are connected and calibrated as described in the *HP/Agilent 8922 Multi-Band Test System Supplementary User's Guide*. See the *HP/Agilent 8922 GSM Test Set User's Guide* and the *HP/Agilent 83220 User's Guide* for details on the rear panel connections.

To make the rear panel connections of the HP/Agilent 8922 GSM HSCSD Test System:

- Step 1.** Connect the system bus cable from the master unit to the slave unit (the end with the BNC connection must be connected to the master unit).

If you are not connecting the BNC connector on the system bus cable to for example, a spectrum analyzer, then terminate the connection using the BNC terminator provided.

- Step 2.** Connect the GPIB cable from the GPIB port on the master unit to the GPIB port on the slave unit.

NOTE

If you are operating the HP/Agilent 8922 GSM HSCSD Test System manually do not connect another GPIB controller to the GPIB bus. The master unit operates as the controller and another device attached to the GPIB bus results in conflicts on the GPIB bus.

- Step 3.** Connect the 10 MHz reference cable from the 10MHz OUT port on the master unit to the Ref IN port on the HP/Agilent 83320 of the slave unit.

The HSCSD connections are shown below.

Setting up the HP/Agilent 8922 GSM HSCSD Test System
Making the rear panel connections

Figure 2-2 Rear panel connections

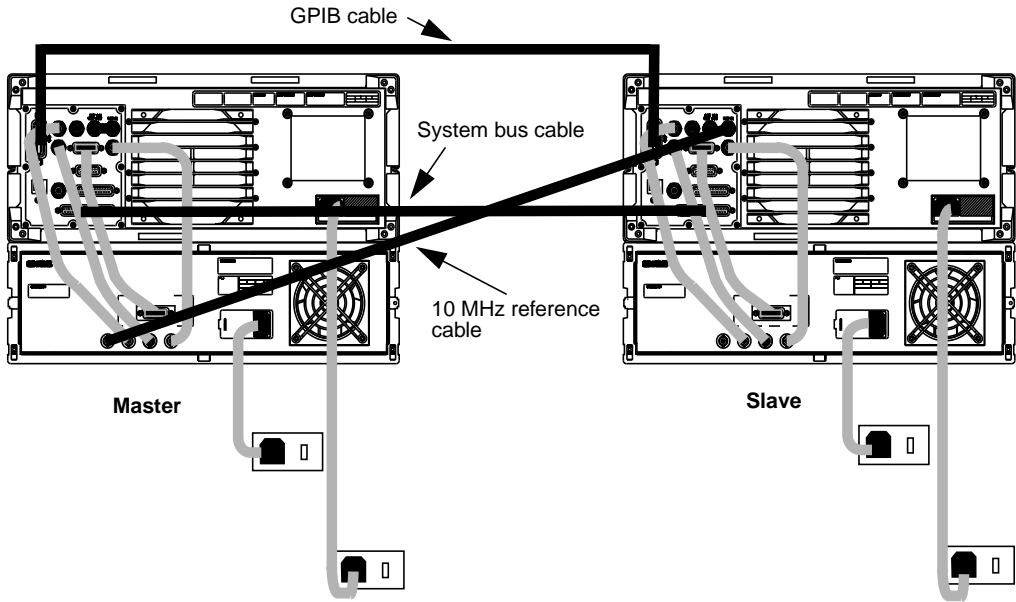

Enabling the HSCSD functionality

You must enable the HSCSD test functionality within the HP/Agilent 8922 using the keycard supplied as follows.

- Step 1.** Power on the HP/Agilent 8922.
- Step 2.** Insert the keycard into the HP/Agilent 8922.

Figure 2-3 **Inserting the keycard into the HP/Agilent 8922**

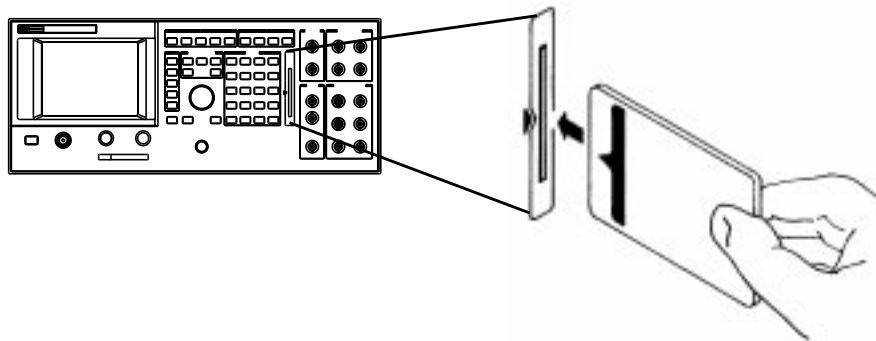

- Step 3.** Press the **TESTS** key on the front panel of the HP/Agilent 8922 to access the TESTS screen.

Setting up the HP/Agilent 8922 GSM HSCSD Test System
 Enabling the HSCSD functionality

Figure 2-4

Tests screen

TESTS	
Procedure: Location Library	Program Autostart
: ROM	: Off/On
Comment	
[Redacted]	
Test Execution Conditions	
On VUT Failure	Run Mode
Continue/Stop	Continuous/Single Step
Output Results	Output Destination
All/Failures	Crt/Printer
Output Heading	
[Redacted]	
Test Function	
Edit Sean	

1 Run Test

2 Continue

Edit Sean

Edit Parm

Edit Spec

To Screen

PHASE FRQ

PWR RAMP

BIT ERROR

OUT RF SP

More

Step 4. Set Location to CARD.

Step 5. Select the Procedure field and select ENABLE as the procedure.

Step 6. Select the Run Test field or press the **[F1]** key on the front panel of the HP/Agilent 8922 to run the program.

The option HSCSD Master is now present in the Instrument Type field in the CONFIGURE screen indicating that the HSCSD functionality is correctly enabled.

Figure 2-5

Config screen

CONFIGURE				
Radio Type GSM900	Reference 10 MHz Normal Calibrate	Intensity 7	RF Level Offset dB On/Off	Meas Cntl MeasReset
Instrument Type HSCSD MASTER	Offset 0.0 PPM	Beeper Quiet	RF In/Out 0.0	OPT 001 REF OUT On/Off
Compatible 8922P/8922G	RFGen Volts 50 ohm/emf	Date 1998 10 29 YYYY MM DD	Aux RFOut 0.0	Screen Freeze Off/On
	Range Hold Auto All Hold All State:Auto	Time 18.08 HH.MM	Aux RF In 0.0	IO Config SERVICE
	Serial Number Info 00000000000000000000 0 0		Firmware c.01.06	To Screen PHASE FRQ PWR RAMP BIT ERROR OUT RF SP More

To disable HSCSD functionality To disable the HSCSD functionality, repeat steps 1 to 4 of the procedure for enabling the functionality, set the Procedure field to DISABLE in step 5 and complete the rest of the procedure.

Calibrating the overall system

There is an RF loss through the system from the slave unit's reported output level to that observed by the mobile due to cable loss and a nominal 7 dB loss through the system. Therefore once you have connected the HP/Agilent 8922 GSM HSCSD Test System and calibrated each unit individually (see the *HP/Agilent 8922 Multi-Band Test System Supplementary User's Guide*), you must calibrate the overall system to account for these losses. To do this you need to adjust the RF Level Offset field on the Config screen. To determine the necessary RF Level Offset adjustments:

- Step 1.** Connect a mobile to the HP/Agilent 8922 master unit and set up a call as described in Chapter 3 , "Manual operation," on page 15.
- Step 2.** Go to HSCSD Control screen on both units and set each unit to measure the master uplink slot.
- Step 3.** Go the Config screen on both units and set the RF Lev Offset so that the transmitted power level of the master and slave units are the same.

When the transmitted power level is the same on both the master and slave units the system is calibrated to account for its RF losses.

NOTE

RF losses may be different for GSM and DCS radio modes, therefore it is recommended that you perform calibration for both GSM and DCS.

NOTE

You must calibrate the system whenever any of the following occur:

- The HP/Agilent 8922 GSM HSCSD Test System is first set up.
 - Any hardware component in the system is changed (HP/Agilent 83220 and/or HP/Agilent 8922).
 - Different IF Link or Aux RF In/Out cables are used.
 - After a RAM Initialize or Firmware Upgrade.
 - You need to troubleshoot the system or localize faults.
-

3 **Manual operation**

This chapter describes the basic procedures required to manually operate the HP/Agilent 8922 GSM HSCSD Test System. For more details on operating procedures, refer to the *HP/Agilent 8922MS User's Guide*.

Configuring the system

To configure the HP/Agilent 8922 GSM HSCSD Test System for manual operation, proceed as follows.

NOTE You must configure the slave unit first as a frame reset is sent from the master unit to the slave unit as soon as the master unit is activated. The slave unit must be ready to receive this frame reset.

NOTE If you are operating the HP/Agilent 8922 GSM HSCSD Test System manually do not connect another GPIB controller such as a PC to the GPIB bus. The master unit operates as the controller and any other device attached to the GPIB bus can result in conflicts on the GPIB bus.

Step 1. On the slave unit, navigate to the CONFIG screen and set the Instrument Type to HSCSD Slave.

Figure 3-1 Config screen

CONFIGURE				
Radio Type GSM900	Reference 10 MHz Normal Calibrate	Intensity 7	RF Level Offset dB On/Off	
Instrument Type HSCSD Slave	Offset 0.0 PPM	Beeper Quiet	RF In/Out 0.0	
Compatible 8922P/8922G	RFGen Volts 50 ohm/emf	Date 2061 1 23 YYYY MM DD	Aux RFOut 0.0	
	Range Hold Auto All Hold All State:Auto	Time 7.22 HH.MM	Aux RF In 0.0	IO Config SERVICE
Meas Cntl MeasReset	OPT 001 REF OUT On/Off	Screen Freeze Off/On	Firmware C.01.06	Instrument: Speech HSCSD Master HSCSD Slave

The slave unit's GPIB address is now automatically set to 15 (seen in the IO Config screen) which is the default Slave Address setting on the master unit. The slave unit's GPIB address must be the same as the Slave Address setting on the master unit and this helps to ensure this.

The slave unit's Operating Mode is also automatically set to Test Mode (seen in the Cell Status screen).

NOTE

If the HP/Agilent 8922 GSM HSCSD Test System is not fitted with a new HOP Controller ROM, selecting HSCSD Master or HSCSD Slave results in the error Hardware portion of upgrade not present. The test set will allow HSCSD operation, however the downlink signal could be scrambled when the TCH ARFCN is on or near the master or slave unit's BCH ARFCN. For details on upgrading the HOP Controller ROM, see Appendix A , "Upgrading the HOP Controller ROM and Firmware," on page 75

Step 2. On the master unit, go to the CONFIGURE screen and set the Instrument Type to HSCSD Master.

The master unit's Operating Mode is now automatically set to Active Cell Mode (seen in the Cell Status screen).

The message Frame reset sent appears in the top left-hand corner of the master unit's screen indicating that the master unit has sent the frame reset to the slave unit.

Note that the Slave Address field is set to 15 as default. This must match the slave unit's GPIB address, therefore if you change the Slave Address setting on the master unit, you must also change the slave unit's GPIB address to match.

Establishing a call

You establish a call in the same way as for a speech call.

- Step 1.** Ensure that the master timeslot is the timeslot currently being measured on the master unit.

To do this, navigate to the HSCSD control screen on the master unit and set the `Measure` field to `Master`. If you do not do this the HP/Agilent 8922 does not see the signalling from the mobile, and call set up fails.

- Step 2.** Configure the call by navigating to the HSCSD control screen on the master unit, and setting `Call Type` as a `2x2` or `2x1` and `Data Rate` to `9.6` or `14.4` kbits/s as required.

- Step 3.** Connect the mobile to the RF IN/OUT port located on the front panel of the master unit's HP/Agilent 83220 (see the *HP/Agilent 8922 Multi-Band Test System Supplementary User's Guide* for more information about this port).

- Step 4.** Switch on the mobile.

The mobile now camps onto the broadcast channel.

- Step 5.** Once the mobile is connected and successfully camped on to the master unit, initiate the call from the mobile (for example, by pressing `SEND` on the mobile, or by pressing `ORG CALL` on the HP/Agilent 8922 master unit). The display on the HP/Agilent 8922 now shows that the call status is `CONNECTED`.

If the call cannot be established, it may be because the uplink power may differ from the HP/Agilent 8922's expected input level. The most likely reason for this type of problem is that the mobile or the IF Link cable has not been calibrated. For details on calibrating the system "Calibrating the overall system" on page 14.

Making measurements

Once a call is established, you can make measurements as before—see the *HP/Agilent 8922 User's Guide* for more details. Note however that there are two new factors which you need to consider: choosing which timeslot to perform measurements on, and performing BER on the two-unit system.

Choosing which timeslot to measure

Any HSCSD instrument can measure the master or the slave timeslot. This selection is made on the HSCSD control screen, and the measurements on this screen include a reminder of which slot is currently being analysed. On other screens, where this reminder is not present, you must be aware of which slot you are measuring.

Measuring BER

To perform BER, one instrument starts a measurement, while the other makes the measurement. Specifically, to perform BER on the slave timeslot, you must start the BER measurement on the master unit because it is the master unit which performs the signalling to place the mobile in loopback mode. Once this is done, the BER measurement must be started on the slave unit, where it will then run as normal. After the measurement is complete, and the master unit is returned to a different screen, the HP/Agilent 8922 signals the mobile and takes it back out of loopback mode.

Changing band and making measurements in the E-GSM900 and DCS 1800 bands

Changing band and making measurements in the E-GSM900 and DCS1800 bands are performed in the same way as for the HP/Agilent 8922 Multi-Band System. See the *HP/Agilent8922 Multi-Band Test System Supplementary User's Guide* for details.

Changing power levels, timeslot and channels

You can change downlink and uplink power, TCH timeslot, and TCH ARFCN simply by typing in a new value on the HSCSD control screen. A dual band channel assignment can be performed using the existing procedure.

Figure 3-2

HSCSD control screen

HSCSD CONTROL			
<u>Downlink amplitude</u> Master -85.0 dBm Slave offset 0.0 dB (-85.0 dBm)		<u>Mobile reports</u> (master timeslot) Tx Lev Rx Lev Rx Qual	
<u>Mobile control</u> Master channel 30 Master timeslot 4 Slave timeslot 5 Call Type 2x2/2x1 Data Rate 9.6/14.4		Peak Power dBm (master timeslot) -----	
<u>Uplink control</u> Tx Lev 15 Input level 13.0 dBm Control MS TX Lev		SLAVE UNIT Downlink on slave timeslot is DISABLED Waiting for sync from master.	To Screen PHASE FRQ PWR RAMP BIT ERROR OUT RF SP More

Ending a call

Ending a call is the same procedure as that used for a standard HP/Agilent 8922 Test System, however the master unit must be measuring the master timeslot. Refer to the *HP/Agilent 8922MS User's Guide* for more information.

NOTE

To ensure that the call ends cleanly, the master unit must be measuring the master timeslot when the call is ended.

Manual operation
Ending a call

4 Screens

This chapter describes the screens that are part of the HP/Agilent 8922 GSM HSCSD Test System. For more details on all other screens, refer to the *HP/Agilent 8922MS User's Guide*. These screens are only available for firmware revision C.01.06 and later.

Config screen

Figure 4-1

Config screen

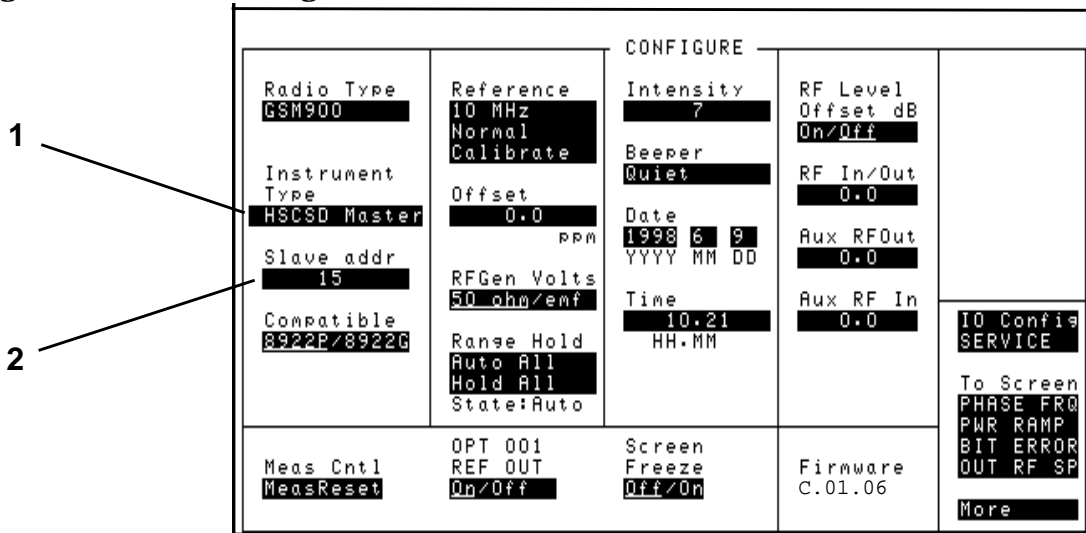

1. Instrument type

Type	menu
Choices	Speech
	HSCSD Master
	HSCSD Slave
Default	Speech

HSCSD Master and HSCSD Slave indicate that the HP/Agilent 8922 is part of a multi-box solution.

Note that selecting HSCSD Master temporarily sets the GPIB control field on the IO Config screen to Control (this happens whenever the master unit sends a user change to the slave unit). Before the master unit can control the slave unit, you must:

- set the slave GPIB address to match the address of the slave unit
- make sure that the addresses of the slave and master units are different
- make sure that no other GPIB controller is active and attached to the system

NOTE

If you are operating the HP/Agilent 8922 GSM HSCSD Test System manually do not connect another GPIB controller such as a PC to the GPIB bus. The master unit operates as the controller and any other device attached to the GPIB bus can result in conflicts on the GPIB bus.

Selecting `HSCSD Slave` sets the GPIB address of the instrument to 15 to match the default slave GPIB address of the master unit.

If the HP/Agilent 8922 GSM HSCSD Test System is not fitted with a new HOP Controller ROM, selecting `HSCSD Master` or `HSCSD Slave` results in the error `Hardware portion of upgrade not present`. The test set will allow HSCSD operation, however the downlink signal could be scrambled when the TCH ARFCN is on or near the master or slave unit's BCH ARFCN. For details on upgrading the HP/Agilent 8922's HOP Controller ROM, see "Upgrading the HOP Controller ROM and Firmware" on page 75.

NOTE

The `Instrument type` field is reset to the default in the event of a reset or power cycle. Setting this field also resets all the default values on the `HSCSD Control` screen.

2. Slave address

Type	integer
Units	none (HP-IB address)
Limits	0 thru 30
Default	15

The `Slave address` field appears only if you have selected `HSCSD Master` as the instrument type and is the address used by the master unit to send GPIB commands to the slave unit. This is only used when the instrument is being operated manually.

NOTE

You must ensure that the GPIB address on the slave unit matches the value configured in the `Slave address` field on the master unit. The GPIB address of the slave unit is set in the `IO Config` screen. However, if you set the instrument type as `HSCSD Slave`, the GPIB address of the slave is automatically set to 15 which is the default value of the `Slave address` field on the master unit.

NOTE

The default value is reset after a reset or power cycle. Note also that changing the instrument type does not reset the value of this field.

HSCSD screen

Figure 4-2 HSCSD Control screen

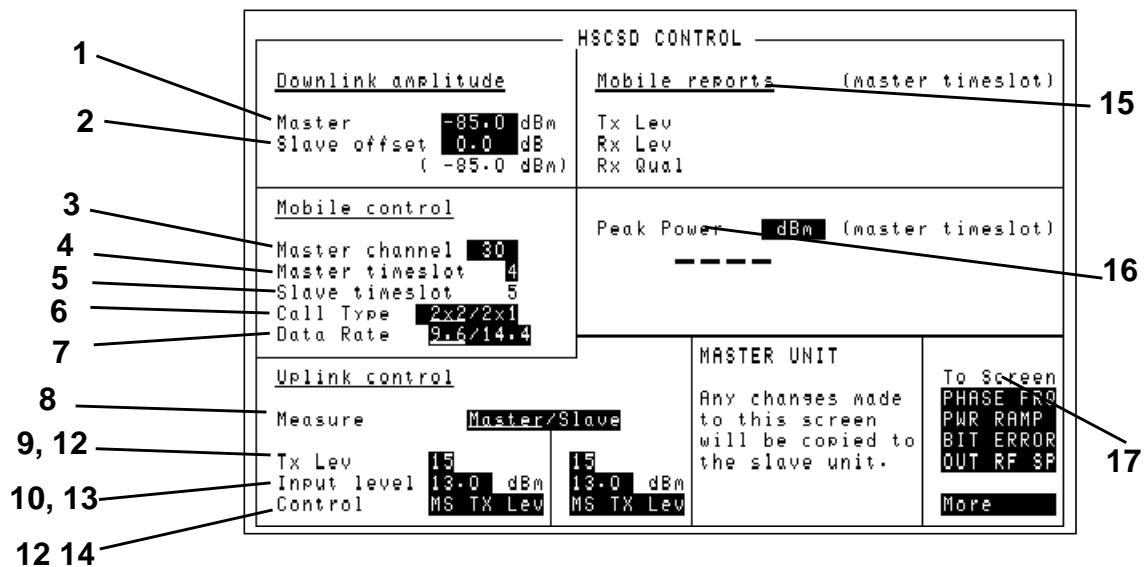

1. Master downlink amplitude

Type	floating point
Units	dBm only
Limits (GSM900)	-127.0 thru +1.0
Limits (E-GSM)	-127.0 thru +1.0
Limits (DCS1800)	-127.0 thru -12.0
Limits (PCS1900)	-127.0 thru -12.0
Default	-85.0

The Master downlink amplitude field shows the downlink amplitude of the master TCH. The amplitude of the slave TCH is calculated by

Screens

HSCSD screen

adding an offset (see page 28) to this value.

NOTE

The default is reset when you select the instrument type (see page 24).

2. Slave offset

Type	floating point
Units	dBm only
Limits (GSM900)	-100.0 thru +100.0
Default	0.0

The `Slave offset` field determines the downlink amplitude of the master TCH by selecting the difference in amplitude between the master and slave amplitudes. Below this field there is a read-only reminder of the absolute level of the slave TCH.

Note that the resultant absolute amplitude must lie within the normal RF generator limits (-127.0 thru +1.0 dBm). The error `Disallowed due to pulse mod configuration` is returned if these limits are exceeded.

On a master unit, changing the `Slave offset` field has no effect other than copying the value to the slave unit when being operated manually.

On a slave unit, changing the `Slave offset` field changes the downlink amplitude of the unit. This field, when added to the master downlink amplitude (see page 27) always has the same value as the RF I/O generator amplitude.

NOTE

The default is reset when the instrument type (see page 24) is selected.

3. Master channel

Type	integer
Units	none (ARFCN)

Limits (GSM900)	1 thru 124
Limits (E-GSM)	0 thru 124; 995 thru 1024
Limits (DCS1800)	512 thru 885
Limits (PCS1900)	512 thru 810
Default (GSM900)	30
Default (E-GSM)	30
Default (DCS1800)	512
Default (PCS1900)	512

The `Master Channel` field shows the ARFCN of the TCH. There is only one ARFCN, as HSCSD systems place all timeslots on the same ARFCN.

On a slave unit, setting this field changes the ARFCN of the downlink TCH and analyzer appropriately.

On a master unit, this field sets the TCH ARFCN of the current call, or the TCH ARFCN to be used for the next call. An assignment command is sent to the mobile on the downlink FACCH.

If you try to change the ARFCN but the measurement timeslot (see page 32) is set to `Slave`, an error occurs and the setting is ignored. Without this error, the acknowledgment from the mobile would be missed if the HP/Agilent 8922 is analyzing the slave timeslot. The error reported is `Select 'Master' to measure before signalling mobile`.

The value of this field is always the same as the TCH ARFCN on the Cell Status screen.

NOTE

The default is reset when the instrument type (see page 24) is selected.

4. Master timeslot

Type	integer
Units	none (timeslot)
Limits	2 thru 5
Default	4

The `Master timeslot` field indicates which timeslot is used for the master TCH. As the slave TCH is always in the timeslot immediately after the master, changing this field sets the slave timeslot to the value “master timeslot plus one”.

On a master unit or a single unit, the value of this field is always the same as the TCH timeslot field on the Cell Status screen.

NOTE

The default is reset when the instrument type (see page 24) is selected.

5. Slave timeslot

Type	read-only
Values	3 thru 6
Default	5

The relative position of the slave timeslot is fixed at +1. Therefore, if the master timeslot is set to 3, the slave timeslot is set to 4. Likewise, as the master timeslot changes, this field also changes.

On a slave unit, the value of this field is always the same as the TCH timeslot field on the Cell Status screen.

NOTE

The default is reset when the instrument type (see page 24) is selected.

6. Call Type

Type	Toggle
Units	None
Default	2x2
Values	2x2 or 2x1

The Call Type field determines which type of HSCSD call the HP/Agilent 8922 establishes the next time a call is initiated.

If you select 2x1, the HP/Agilent 8922 tries to establish a call with 2 downlinks and 1 uplink when a call is next initiated. The measure timeslot field will no longer be visible, nor will the controls concerned with the second uplink (Slave TX level, Slave input level, Slave input level control mode).

If you select 2x2, the HP/Agilent 8922 sets up a call with 2 downlinks and 2 uplinks. The Measure timeslot field appears, along with controls associated with the second uplink. The Measure timeslot field is set to the default for each unit (slave for slave, master for master).

NOTE

Each of these changes is subject to the conditions that a call must not be in progress when the change to this field is made and that the field will not change if changing the slave timeslot would make it take on an illegal value.

7. Data rate

Type	Toggle
Units	None
Choices	“9.6” or “14.4”
Default	“9.6”

The `Data rate` field determines the data rate associated with the HSCSD 2x2 call. Selecting '9.6' sets up a call at 9.6 kbit/s per timeslot (19.2 kbit/s) and selecting '14.4' sets up a call at 14.4 kbit/s per timeslot (28.8 kbit/s).

NOTE

The value of the `Data rate` field can not be changed while a call is in progress.

8. Measure

Type	Toggle
Units	None
Choices	“Master” or “Slave”
Default (slave unit)	“Slave”
Default (other units)	“Master”

The `Measure` field sets which of the uplink TCHs are to be measured or demodulated. The display updates (next to the `Mobile reports` and `Peak Power` displays) to show which timeslot is being analyzed.

The `Measure` field also selects which analyzer level to use, either the Master input level (see page 34) or the Slave input level (see page 36).

NOTE

The default is reset when you select the instrument type (see page 24).

9. Master Tx level

Type	integer
Units	none (Tx level)
Limits (GSM900)	1 thru 19
Limits (E-GSM)	1 thru 19
Limits (DCS1800)	0 thru 15
Limits (PCS1900)	0 thru 15; 30 thru 31
Default (GSM900)	15
Default (E-GSM)	15
Default (DCS1800)	10
Default (PCS1900)	10

On a master unit, the `Master Tx level` field requests a new transmit level for the uplink master TCH. On a slave unit, this field does not make this request.

If the instrument is operating in standard mode, setting this field changes the master mode (see page 35) to `MS TX Lev`, then calculates and sets the master's expected input level (see page 34). If the instrument is operating in compatibility mode, setting this field only changes the master's expected input level when the control type for the master is set to `MS TX Lev`.

NOTE

The default is reset when you select the instrument type (see page 24).

10. Master input level

Type	float
Units	dBm only
Limits (GSM900)	-27 thru +41.0
Limits (E-GSM)	-27 thru +41.0
Limits (DCS1800)	-47 thru +33.0
Limits (PCS1900)	-47 thru +33.0
Default (compatibility mode)	33.0
Default (GSM900)	13.0
Default (E-GSM)	13.0
Default (DCS1800)	10.0
Default (PCS1900)	10

The Master Input level field sets the expected power of the master uplink TCH. You can set the level indirectly by changing the master Tx level (see page 33) or you can change it directly. This value is used to set the RF analyzer level when the measurement timeslot (see page 32) is set to Master.

If the instrument is operating in standard mode, setting this field changes the master control type (see page 35) to Manual.

If the instrument is operating in compatibility mode and the master control type is MS TX Lev, then the instrument returns the error Can't change setting while MS TX Lev mode is selected and does not make the setting.

When the measurement timeslot is set to Master, this field always has the same value as the RF I/O analyser level.

NOTE

The default is reset when you select the instrument type (see page 24).

11. Master mode

Type	menu
Choices	“Manual”, “MS Tx Lev”
Default (compatibility mode)	“Manual”
Default (standard mode)	“MS Tx Lev”

The `Master mode` field either makes or breaks the link between the `Master Tx level` (see page 33) and the `Master input level` (see page 34).

NOTE

Note that in standard mode, setting either of these other values change the `Master mode` field. See the description of these fields for an explanation of the level control mode.

12. Slave Tx level

Type	integer
Units	none (Tx Level)
Limits (GSM900)	1 thru 19
Limits (E-GSM)	1 thru 19
Limits (DCS1800)	0 thru 15
Limits (PCS1900)	0 thru 15; 30 thru 31
Default (GSM900)	15
Default (E-GSM)	15
Default (DCS1800)	10
Default (PCS1900)	10

On the slave, the `Slave Tx level` field sets the transmit level (Tx Level) of the slave TCH.

Screens

HSCSD screen

On both units, if the instrument is operating in standard mode, setting this field changes the slave control field (see page 37) to MS Tx Lev, then calculates and sets the slave expected input level (see page 36). If the instrument is operating in compatibility mode, setting this field only changes the slave expected input level when the slave control type is MS Tx Lev.

NOTE

The default is reset when you select the instrument type (see page 24).

13. Slave input level

Type	float
Units	dBm only
Limits (GSM900)	-27 thru +41.0
Limits (E-GSM)	-27 thru +41.0
Limits (DCS1800)	-47 thru +33.0
Limits (PCS1900)	-47 thru +33.0
Default (compatibility mode)	33.0
Default (GSM900)	13.0
Default (E-GSM)	13.0
Default (DCS1800)	10.0
Default (PCS1900)	10.0

The Slave input level field sets the expected power of the slave uplink TCH. You can set the level indirectly by changing the Slave Tx level (see page 35) or change it directly. This value is used to set the RF analyzer level when the measurement timeslot (see page 32) is set to Slave.

If the instrument is operating in standard mode, setting this field changes the slave control type (see page 37) to Manual.

If the instrument is operating in compatibility mode, and the slave

control type is MS Tx Lev, then the instrument returns an error (Can't change setting while MS TX Lev mode is selected.) and does not make the setting.

NOTE The default is reset when you select the instrument type (see page 24).

14. Slave control

Type	menu
Choices	“Manual”, “MS Tx Lev”
Default (compatibility mode)	“Manual”
Default (standard mode)	“MS Tx Lev”

The `Slave control` field either makes or breaks the link between the slave Tx level (see page 35) and the slave input level (see page 36).

NOTE Note that in standard mode, setting either of these other values changes this field. See the description of these fields for an explanation of the level control mode.

NOTE The default is reset when you select the instrument type (see page 24).

15. Mobile reports

The Mobile Reports are the same uplink SACCH reports as appear on the Cell Status screen. The reports are taken from whichever uplink timeslot is currently being analysed. You make this choice using the Measurement timeslot field (see page 32).

16. Peak power display

The Peak Power display is the same measurement as appears on the Cell Status screen. The measurement is made on whichever uplink timeslot is currently being analyzed. You make this choice using the Measurement timeslot field (see page 32). A reminder of which timeslot is currently being analysed appears on the right if the peak power display.

17. To Screen menu

For HSCSD, all of the To Screen and More menus are only changed in one way; the addition of the HSCSD choice, which selects the screen as described in page 32.

Fast BER Screen

One extra field, labelled Loopback, appears in the Fast Bit Error screen, when the HP/Agilent 8922 is in 2x1 mode.

Figure 4-3

Fast BER screen

FAST BIT ERROR				
BE Ratio <input type="text" value="2"/>				
MOBILE REPORTS : RX Qual RX Lev				
Intermediate Results For Bits				
BE Ratio <input type="text" value="2"/>				
CONTROL	MEASURE	BASE STATION	MS LOOPBACK	MOBILE
Single/Cont Run/Stop	10000 Bits	Amplitude -85.0 dBm Data Format Rand Speech	Burst Delay 5 Auto Loopback Master/Slave	Chan 30 TX Lev 15 Timeslot 4 Type FS More

The Loopback field is a toggle field and allows the choice of either master or slave. This instructs the mobile to either loopback the master channel on the downlink to the master uplink or loopback the slave downlink to the master uplink.

Note that toggling the Loopback field does not immediately instruct the mobile to perform a loopback using the contents. Entering the screen sends the command to the mobile to close the loop. It is therefore necessary to enter the screen with this field set to loopback the downlink channel of choice.

NOTE

When performing Fast BER on the slave channel, it is necessary to start the measurement on the master unit because the master unit controls all the signalling with the mobile). As a result, this also starts a Fast BER measurement on the master unit which should be ignored.

Screens
Fast BER Screen

Loopback

Type	toggle
Choices	“Master”, “Slave”
Default	“Master”

The `Loopback` field selects which downlink slot is looped back on the master uplink.

5 Remote operation

This chapter explains how to operate the HP/Agilent 8922 GSM HSCSD Test System over the GPIB. The new GPIB commands for the HP/Agilent 8922 GSM HSCSD Test System are detailed. For the syntax format of all other GPIB commands, see the *Agilent 8922MS Programming Reference Guide*.

Introduction

The general principle of operation is that the settings on the slave unit are relative to the settings on the master unit which allows the manual and remote interfaces to operate in the same way. It is therefore necessary to always consider the relationship between the two timeslots.

Call setup and changing channels are handled by the master unit. However, it is vital that the slave unit remains on the same channel and timeslot (offset by one) as the master unit. Unlike the manual user interface, where a change made on the master unit is copied to the slave, controlling the system remotely involves taking control of both units. As most of the settings on the slave unit are relative to the master unit, the slave unit must know the configuration of the master unit. The following command sequence is a general example of how this is achieved.

```
MasterAddr=715  
SlaveAddr=716  
OUTPUT MasterAddr;"HSCSD:MASTER:COMMAND <parameters>"  
OUTPUT SlaveAddr;"HSCSD:MASTER:COMMAND <parameters>"  
OUTPUT SlaveAddr;"HSCSD:SLAVE:COMMAND <parameters>"
```

Configure Subsystem GPIB Commands

Figure 5-1 **Configure Instrument Type comand syntax**

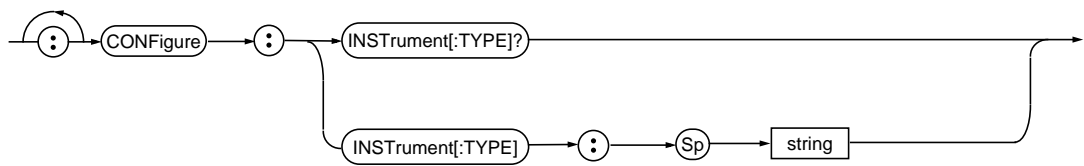

CONFigure:INSTrument[:TYPE]

Description	<p>Sets what role the HP/Agilent 8922 plays in the multi-slot test system. This selection differs from manually selecting the instrument type in two ways: the GPIB status does not change to <code>Control</code>, and the unit's GPIB address does not change.</p> <p>Note that you need to manually select two different GPIB addresses for the master and slave units.</p> <p>If the instrument has not been fitted with a new hop controller ROM, selecting <code>HSCSD Master</code> or <code>HSCSD Slave</code> results in the error <code>Hardware portion of upgrade not present</code>. In this case the instrument allows HSCSD operation, but the downlink signal could be scrambled when the TCH ARFCN is placed on or near to the master or slave's BCH ARFCN.</p>
Syntax	<p><code>CONFigure:INSTrument[:TYPE]?</code> <code>CONFigure:INSTrument[:TYPE] <string></code></p>
Command options	<p>'SPEECH' 'HSCSD MASTER' 'HSCSD SLAVE'</p>

Display Subsystem GPIB Commands

Figure 5-2 Display Screen command syntax

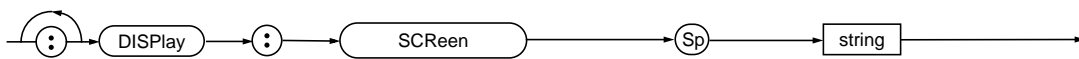

DISPlay:SCReen HSCSD

- Description** This command selects the HSCSD control screen (or an error screen if the system is not upgraded to run HSCSD).
- Syntax** DISPlay:SCReen <string>
- Command options** 'HSCSD'

HSCSD Subsystem GPIB Commands

Remote operation
HSCSD Subsystem GPIB Commands

Figure 5-3 HSCSD command syntax (master unit)

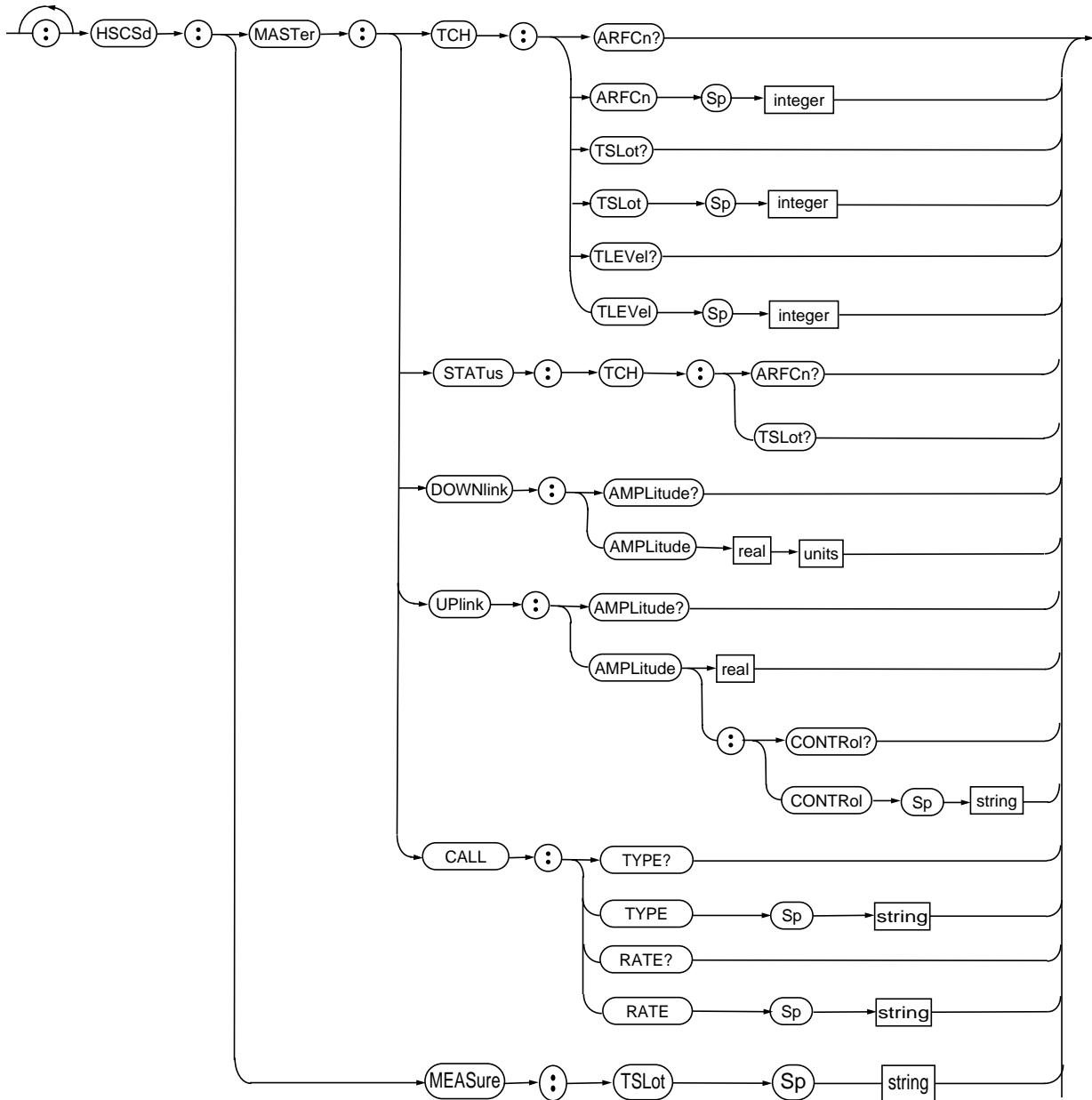
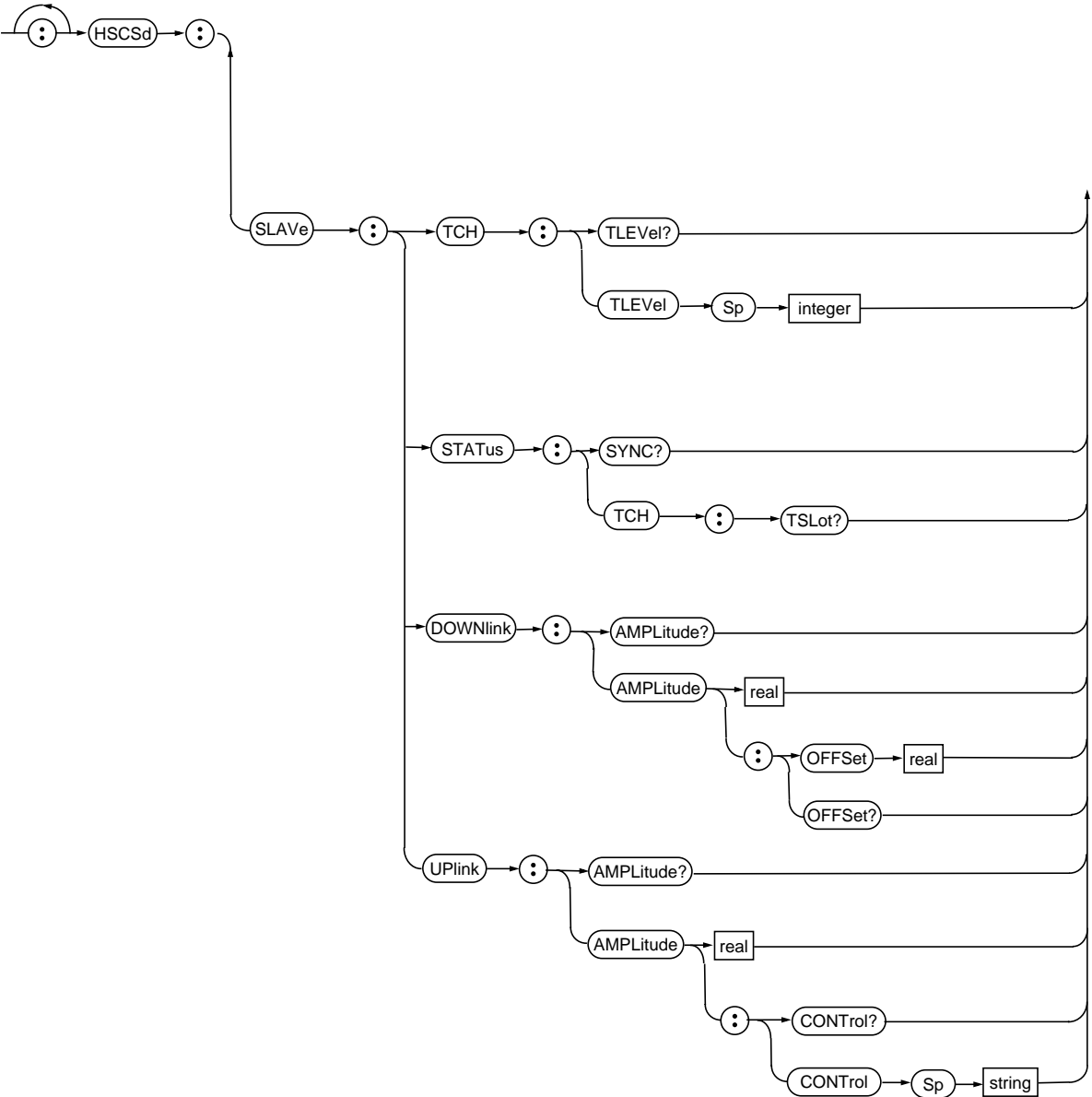

Figure 5-4 HSCSD command syntax (slave unit)



HSCSd:MASTer:TCH:ARFCn

Description

Setting this during a call forces a channel assignment to the given channel. Note that existing channel assignment commands sent to a master or single unit have the same effect. In particular, a dual band assignment must be performed using the existing dual band commands. If the measurement timeslot is not set to “Master”, attempting to perform a channel assignment on a master or single unit will produce an error, and the setting will be ignored. The error message is *Select Master to measure before signalling mobile*. When the system is idle (that is, not on a call) this sets the channel which will be used when the next call is established. This command must also be sent to the slave unit.

Syntax

HSCSd:MASTer:TCH:ARFCn <integer>
HSCSd:MASTer:TCH:ARFCn?

Command options

Type	integer
Units:	none (ARFCN)
Limits (GSM900):	1 thru 124
Limits (E-GSM):	0 thru 124; 995 thru 1024
Limits (DCS1800):	512 thru 885
Limits (PCS1900):	512 thru 810
Default (GSM900):	30
Default (E-GSM):	30
Default (DCS1800):	512
Default (PCS1900):	51

HSCSd:MASTer:STATus:TCH:TSLot

Description

Setting this during a call changes the master timeslot. Note that existing timeslot commands sent to a master or single unit have the same effect. When the system is idle (that is, not on a call) this sets the timeslot which will be used when the next command is established. In a multi-box system, this command must also be sent to the slave unit.

Note that the slave timeslot is always the slot following the master. Consequently, in a multi-box system, the slave needs to know only the master timeslot.

Syntax

HSCSd:MASTer:STATus:TCH:TSLot <integer>
HSCSd:MASTer:STATus:TCH:TSLot?

Command options

Type	integer
Units:	none (timeslot)
Limits:	2 thru 5
Default:	4

HSCSd:MASTer:DOWNlink:AMPLitude

Description This sets the downlink amplitude of the master TCH. In all cases, this sets the TCH level. To change the amplitude of the GSM BCH in a dual band system, use the existing command `DUALband:ATTenuation:GBCh`. See the *HP/Agilent 8922 Multi-Band Test System Supplementary User's Guide* for more details.

This command must also be sent to the slave unit.

Syntax HSCSd:MASTer:DOWNlink:AMPLitude?
HSCSd:MASTer:DOWNlink:AMPLitude <real>

Command Options

Type	floating point
Units:	dBm only
Limits (GSM900):	-127.0 thru +1.0
Limits (E-GSM):	-127.0 thru +1.0
Limits (DCS1800):	-127.0 thru -12.0
Limits (PCS1900):	-127.0 thru -12.0
Default:	-85.0

HSCSd:MASTer:TCH:TLEVel

Description

During a call, this sets the Tx level of the master TCH.

When the system is idle (that is, not on a call), this sets the Tx level to be used when the next call is established. Note that this value is used initially for both timeslots. It is only once the TCH is established, and the mobile begins to decode the downlink SACCH, that the individual Tx levels are used.

In standard mode, this also sets the master unit's uplink amplitude control to MS_{TX_LEV} , and calculates and sets the master unit's expected uplink amplitude. See [reference] below for details of these commands.

Syntax

HSCSd:MASTer:TCH:TLEVel?
HSCSd:MASTer:TCH:TLEVel <integer>

Command options

Type	integer
Units:	none (Tx Level)
Limits (GSM900):	1 thru 19
Limits (E-GSM):	1 thru 19
Limits (DCS1800):	0 thru 15
Limits (PCS1900):	0 thru 15; 30 thru 31
Default (GSM900):	15
Default (E-GSM):	15
Default (DCS1800):	10
Default (PCS1900):	10

HSCSD:MASTer:UPLink:AMPLitude

Description This sets the expected input level of the master TCH. In standard mode, this sets the master's uplink amplitude control to `MANUAL`. In compatibility mode, if the master's uplink amplitude control is set to `MS TX LEV` then an error message `Can't change setting while MS TX Lev mode is selected.` occurs and the setting is not performed.

If the measurement timeslot is set to `Master`, the analyser level of the unit is set to this value.

Syntax HSCSD:MASTer:UPLink:AMPLitude?
HSCSD:MASTer:UPLink:AMPLitude <real> <units>

Command options

Type	float
Units:	dBm only
Limits (GSM900):	-27.0 thru +41.0
Limits (E-GSM):	-27.0 thru +41.0
Limits (DCS1800):	-47.0 thru +33.0
Limits (PCS1900):	-47.0 thru +33.0
Default (compatibility mode):	33.0
Default (GSM900)	13.0
Default (E-GSM):	13.0
Default (DCS1800):	10.0
Default (PCS1900):	10.0

HSCSd:MASTer:UPLink:AMPLitude:CONTrol

Description	<p>This defines the relationship between the master's Tx level, and the master's expected uplink amplitude. <code>MS TX LEV</code> indicates that setting the master's Tx level also sets the master's expected uplink amplitude. <code>MANUAL</code> indicates that setting the master's expected uplink amplitude is independent from the value of the master's Tx level.</p> <p>Note that in standard mode, setting either the master's Tx level, or the master's expected uplink amplitude, forces the value of the master's amplitude control to <code>MS TX LEV</code> or <code>MANUAL</code> respectively.</p>
Syntax	<pre>HSCSd:MASTer:UPLink:AMPLitude:CONTrol? HSCSd:MASTer:UPLink:AMPLitude:CONTrol <string></pre>
Command options	<code>'MS TX LEV'</code> <code>'MANUAL'</code>

Remote operation

HSCSD Subsystem GPIB Commands

HSCSD:MASTer:CALL:TYPE

Description This command selects which type of call the HP/Agilent 8922 will set up the next time a call is initiated.

Syntax HSCSD:MASTer:CALL:TYPE
HSCSD:MASTer:CALL:TYPE?

Command options

Type	toggle
Units	none
Choices	2x2 or 2x1
Default	2x2

HSCSD:MASTer:CALL:RATE

Description This command selects the data rate of the call that the HP/Agilent 8922 will set up the next time a call is initiated.

Syntax HSCSD:MASTer:CALL:RATE
HSCSD:MASTer:CALL:RATE?

Command options

Type	toggle
Units	none
Choices	9.6 or 14.4
Default	9.6

Remote operation

HSCSD Subsystem GPIB Commands

HSCSd:SLAVe:STATus:SYNC

Description	This read-only field indicates whether or not the slave unit is synchronised with the master unit. The status is set to <code>DISABLED</code> when you set the instrument type to <code>HSCSD SLAVE</code> . This must be done before configuring the master unit. When the master unit is configured as <code>HSCSD MASTER</code> , a frame reset is sent from the master unit to the slave unit. Upon receiving this reset, the slave unit starts to generate a TCH, and the sync status field changes to <code>ENABLED</code> .
Syntax	HSCSd:SLAVe:STATus:SYNC?
Command options	Not applicable.

HSCSd:SLAVe:STATus:TCH:TSLot?

Description	This query returns the absolute timeslot. For example, if the master's timeslot is 3, because the slave's timeslot offset is fixed at +1, HSCSd:SLAVe:STATus:TCH:TSLot? would return 4.
Syntax	HSCSd:SLAVe:STATus:TCH:TSLot?
Command options	Not applicable.

Remote operation

HSCSD Subsystem GPIB Commands

HSCSd:SLAVe:DOWNlink:AMPLitude:OFFSet

Description

This sets the amplitude offset (in dBs) of the slave timeslot, using the master's downlink amplitude as a reference.

The resulting amplitude must lie within the normal downlink power range. If not, the error `Disallowed` due to pulse mod configuration is produced, and the setting is ignored.

Syntax

HSCSd:SLAVe:DOWNlink:AMPLitude?
HSCSd:SLAVe:DOWNlink:AMPLitude:OFFSet <real>

Command options

Type	floating point
Units:	dB only
Limits	-100.0 thru 100.0
Default	0.0

HSCSd:SLAVe:TCH:TLEVel

Description

During a call, this sets the Tx level of the slave TCH. When the system is idle (that is, not on a call), this sets the Tx level to be used when the next call is connected and the slave TCH is established.

Note that this is not the Tx Level first used to establish the TCH. In standard mode, this also sets the slave's uplink amplitude control to `MS TX LEV`, and calculates and sets the slave's expected uplink amplitude.

Syntax

HSCSd:SLAVe:TCH:TLEVel?
HSCSd:SLAVe:TCH:TLEVel <integer>

Command options

Type	integer
Units:	dBm only
Limits (GSM900):	1 thru 19
Limits (E-GSM):	1 thru 19
Limits (DCS1800):	0 thru 15
Limits (PCS1900):	0 thru 15; 30 thru 31
Default (GSM900):	15
Default (E-GSM):	15
Default (DCS1800):	10
Default (PCS1900):	10

HSCSd:SLAVe:UPLink:AMPLitude

Description This sets the expected input level of the slave timeslot.
In standard mode, this sets the slave's uplink amplitude control to `MANUAL`. In compatibility mode, if the slave's uplink amplitude control is set to `MS TX LEV` then an error occurs and the setting is not performed. If the measurement timeslot (see page 43) is set to `Slave`, the analyser level of the unit is set to this value.

Syntax HSCSd:SLAVe:UPLink:AMPLitude?
HSCSd:SLAVe:UPLink:AMPLitude <real> <units>

Command options

Type	float
Units:	dBm only
Limits (GSM900):	-27.0 thru +41.0
Limits (E-GSM):	-27.0 thru +41.0
Limits (DCS1800):	-47.0 thru +33.0
Limits (PCS1900):	-47.0 thru +33.0
Default (compatibility mode):	33.0
Default (GSM900)	13.0
Default (E-GSM):	13.0
Default (DCS1800):	10.0
Default (PCS1900):	10.0

HSCSd:SLAVe:UPLink:AMPLitude:CONTrol

Description	<p>This defines the relationship between the slave Tx level, and the slave expected uplink amplitude. <code>MS TX LEV</code> indicates that setting the slave's Tx level also sets the slave's expected uplink amplitude. <code>MANUAL</code> indicates that setting the slave's expected uplink amplitude is independent from the value of the slave's Tx level.</p> <p>Note that in standard mode, setting either the slave Tx level, or the slave expected uplink amplitude, forces the value of the slave amplitude control to <code>MS TX LEV</code> or <code>MANUAL</code> respectively.</p>
Syntax	<pre>HSCSd:SLAVe:UPLink:AMPLitude:CONTrol HSCSd:SLAVe:UPLink:AMPLitude:CONTrol?</pre>
Command options	<code>'MS TX LEV' 'MANUAL'</code>

Remote operating procedures

NOTE

For remote operation to work:

- the two HP 8922P units must be put into master and slave mode by remote control
 - HSCSD settings must be made on both HP/Agilent 8922 P units
-

Configuring the system

The slave unit must be configured and initialized before the master unit. Note that unlike manual configuration, the GPIB address of the slave unit does not have to be synchronized on both units.

```
! Configure instruments; note we do slave first
! for a single box, we send the single command
! selecting 'HSCSD SINGLE'
OUTPUT Slave;"CONFIGURE:INSTRUMENT:TYPE 'HSCSD SLAVE'"
WAIT 3 !to make sure we are ready to receive reset from master
OUTPUT Master;"CONFIGURE:INSTRUMENT:TYPE 'HSCSD MASTER'"
```

The slave unit must wait for the frame reset from the master unit.

```
! select HSCSD screen
OUTPUT Master;"DISPLAY:SCREEN HSCSD"
OUTPUT Slave;"DISPLAY:SCREEN HSCSD"
! and wait for slave to receive reset from master
REPEAT !
OUTPUT Slave;"HSCSD:SLAVE:STATUS:SYNC?"
ENTER Slave;sync$
UNTIL sync$="" "ENABLED" ""
!
```

Establishing a call

The procedure for establishing a call is the same as for speech. Note however, that you must be measuring the master uplink in the master unit.

```
! establish a call, mobile terminated
! note we only use the master to do this
! make sure master is demodulating the master uplink
OUTPUT Master;"HSCSD:MEASure:TSLot `SLAVE`"
!
OUTPUT Master;"DISPLAY:SCREEN CELL1"
OUTPUT Master;"CELL:CALL:ORIGINATE"
REPEAT
OUTPUT Master;"CELL:CALL:STATUS:STATE?"
ENTER Master;state$
UNTIL state$="""CONNECTED"""
!
```

Making measurements

Once a call is established, measurements are made as before.

Any HSCSD instrument can measure the master or the slave timeslot.

```
!
! analyse slave uplink on master unit
OUTPUT Master;"HSCSD:MEASure:TSLot `SLAVE`"
! make measurements as before
!
! now analyse master uplink
OUTPUT Master;"HSCSD:MEASure:TSLot `MASTER`"
```

BER on a two unit system which is in 2x1 mode is complicated by the fact that the measurement must be started using the master unit, which performs the signalling with the mobile phone. Specifically, to perform BER on the slave timeslot, you must start the BER measurement on the master unit. This is because it is the master system which performs the signalling to place the mobile in loopback mode. Once this is done, the BER measurement must be started on the slave unit, where it then runs as normal. After the measurement is complete, the master unit returns to a different screen which causes the HP/Agilent 8922 to signal the mobile and take it back out of loopback mode.

Changing channels, timeslot and power levels

Performing a channel assignment is a single instruction. Note that the slave unit must be kept in step with the master and the master must be measuring the master uplink prior to performing a channel assignment. Note also that a dual band channel assignment can be performed using the existing procedures.

```
!  
OUTPUT Master;"HSCSD:MASTER:MEASURE:TSL0T 'MASTER' "  
OUTPUT Master;"HSCSD:MASTER:TCH:ARFCN 1"  
OUTPUT Slave;"HSCSD:SLAVE:TCH:ARFCN 1"
```

Changing timeslot is similar, and must also be performed when analysing the master uplink.

```
!  
! select time slot  
OUTPUT Master;"HSCSD:MASTER:TCH:TSL 2"  
OUTPUT Slave;"HSCSD:SLAVE:TCH:TSL 2"
```

Changing Tx Level is also simple. Note that Tx Level is not relative to the master setting, so the master level does not have to be sent to the slave unit. It does not matter which timeslot is being analysed at the time.

```
! OUTPUT  
Master;"HSCSD:MASTER:TCH:TLEVEL 15"  
OUTPUT Slave;"HSCSD:SLAVE:TCH:TLEVEL 5"
```

Setting the downlink power is simple as the slave offset can be any value.

```
!  
OUTPUT Master;"HSCSD:MASTER:DOWNLINK:AMPLITUDE -70"  
OUTPUT Slave;"HSCSD:MASTER:DOWNLINK:AMPLITUDE -70"  
OUTPUT Slave;"HSCSD:SLAVE:DOWNLINK:AMPLITUDE:OFFSET -30"
```

Ending a call

Ending a call is performed in the same way as for speech.

NOTE

The master or single unit must be measuring the master timeslot for the call to end cleanly.

OUTPUT Master; "CELL:CALL:END"

Note that only the master unit is used.

Example code showing a dual-band handover from E-GSM to DCS

Some example code is listed below which performs a dual-band handover from E-GSM to DCS on an HP/Agilent 8922 GSM HSCSD Test System. The technique is to use the standard dual-band command sequence, but send this to both HP/Agilent 8922 units. Note that after ending a call, the slave unit remains in the DCS band, therefore it is good practice to set the radio band prior to starting the HSCSD call.

```
10 RE-SAVE "TwoBoxDB.bas"
20 !
30 ! Initialise program
40 !
50 CLEAR SCREEN
60 PRINT "Initialising program..."
70 Master=714
80 Slave=715
90 Master_loss=4.1
100 Slave_loss=11.8
110 !
120 CLEAR Master/100
130 CLEAR Master
140 CLEAR Slave/100
150 CLEAR Slave
160!
170! Initialise instruments
180! SLAVE FIRST!
190!
210 !
220 ! Select E-GSM so we can perform dual band handover
230 !
240 OUTPUT Master;"Conf:Radio 'E-GSM'"
250 OUTPUT Slave;"Conf:Radio 'E-GSM'"
260 WAIT 3
270 OUTPUT Slave;"Conf:Inst 'HSCSD Slave'"
280 OUTPUT Master;"Conf:Inst 'HSCSD Master'"
290 REPEAT
300 WAIT .5
310 OUTPUT Slave;"HSCSD:Slave:Status:Sync?"
320 ENTER Slave;Sync$
330 UNTIL Sync$="" "ENABLED" ""
340 ! Note that if the slave instrument has not had hscsd
```

Example code showing a dual-band handover from E-GSM to DCS

```

350 ! enabled, it will IMMEDIATELY return ENABLED
360 !
370 ! Select the HSCSD screen - it's easier to see what's
380 ! happening for now
390 OUTPUT Master;"DISP HSCSD"
400 OUTPUT Slave;"DISP HSCSD"
410 !
420 ! Dial in RF losses
430 !
440 OUTPUT Master;"Conf:OFLevel:RFInOut ";-1*Master_loss
450 OUTPUT Master;"Conf:OFLevel:Mode 'On'"
460 OUTPUT Slave;"Conf:OFLevel:RFInOut ";-1*Slave_loss
470 OUTPUT Slave;"Conf:OFLevel:Mode 'On'"
480 !
490 ! select big tx levels
500 OUTPUT Master;"HSCSD:Master:TCH:TLevel 5"
510 OUTPUT Slave;"HSCSD:Slave:TCH:TLevel 5"
520 !
530 ! Get a call up
540 !
550 ! Make sure master is listening to master uplink
560 !
570 OUTPUT Master;"HSCSD:Measure:TSlot 'Master'"
580 !
590 ! and wait for the call
600 !
610 PRINT "Make a call from the mobile..."
620 REPEAT
630     WAIT .5
640     OUTPUT Master;"Cell:Call:Stat:Stat?"
650     ENTER Master;Stat$
660     UNTIL Stat$="" "CONNECTED""
670 PRINT "Call connected, press CONTINUE key to continue..."
680 PAUSE
690 !
700 ! Now perform a dual band handover 710 !
720 OUTPUT Master;"Disp DBand"
730 OUTPUT Slave;"Disp DBand"
740 OUTPUT Master;"DualBand:TCH:DCS 615"
750 OUTPUT Master;"DualBand:TLevel:DCS 6"
760 OUTPUT Master;"DualBand:Atten:GBCH '10 dB'"
770 OUTPUT Master;"DualBand:Amplitude:DTCH -55 dBm"
780 OUTPUT Slave;"DualBand:TCH:DCS 615"
790 OUTPUT Slave;"DualBand:TLevel:DCS 6"
800 OUTPUT Slave;"DualBand:Atten:GBCH '10 dB'"
810 OUTPUT Slave;"DualBand:Amplitude:DTCH -55 dBm"

```

Remote operation

Example code showing a dual-band handover from E-GSM to DCS

```
820 !
830  OUTPUT Master;"DualBand:TCHC:Exec"
840  OUTPUT Slave;"DualBand:TCHC:Exec"
850  WAIT 3
860 !
870  OUTPUT Master;"Disp HSCSD"
880  OUTPUT Slave;"Disp HSCSD"
890 !
900 !
910 ! Terminate program
920 !
930  LOCAL Master
940  LOCAL Slave
950  STOP
960  END
```

6 **Returning equipment for repair**

Return Procedure

If you need to return your HP/Agilent 8922 or HP/Agilent 83220 to Agilent Technologies, first obtain the correct Service Center shipping address from your local sales office and proceed as follows.

Refer to *Sales and Service Offices* on page 72 for contact information.

CAUTION

Instrument damage can result from using packaging materials other than the original shipping materials or equivalent. Never use styrene pellets as packaging materials. They do not adequately cushion the instrument, do not prevent it from shifting in the carton, and can cause instrument damage due to ESD.

- Please send the following information with the returned instrument:
 - Type of service required.
 - Description of the problem and whether it is constant or intermittent.
 - Name and phone number of technical contact person.
 - Return address.
 - Model number of returned instrument.
 - Full serial number of returned instrument.
 - List of any accessories returned with instrument
- Send copies of any performance data recorded for the instrument.
- Pack the instrument in the original shipping materials or the equivalent.
- If the original shipping materials are not available, follow these steps to repackage the instrument for shipment:
 1. Wrap the instrument in antistatic plastic to reduce the possibility of ESD-caused damage.
 2. Obtain a double-walled, corrugated cardboard carton of 159 kg (350 lb) test strength. The carton must be large enough and strong

enough to accommodate the instrument. Allow at least 7 to 10 cms on all sides of the instrument for packing material.

3. Surround the instrument with 7 to 10 cms of packing material to protect it and prevent it from moving in the carton.
4. Seal the carton with strong nylon adhesive tape.
5. Mark the carton "FRAGILE, HANDLE WITH CARE."
6. Retain copies of all shipping papers.

Sales and Service Offices

Any adjustment, maintenance, or repair of this product must be performed by qualified personnel. Contact your customer engineer through your local Agilent Technologies Service Center. You can find a list of local service service representatives on the web at.

<http://www.agilent-tech.com/services/English/index.html>

You can also contact one of the following centers and ask for a test and measurement sales representative.

Asia Pacific:

Agilent Technologies
19/F, Cityplaza One, 1111 King's Road,
Taikoo Shing, Hong Kong, SAR
(tel) (852) 2599 7889
(fax) (852) 2506 9233

Japan:

Agilent Technologies Japan Ltd.
Measurement Assistance Center
9-1, Takakura-Cho, Hachioji-Shi
Yokyo, 192-8510
(tel) (81) 426 56 7832
(fax) (81) 426 56 7840

Australia/New Zealand:

Agilent Technologies Australia Pty Ltd
347 Burwood Highway
Forest Hill, Victoria 3131
(tel) 1-800 629 485 (Australia)
(fax) (61 3) 9272 0749
(tel) 0 800 738 378 (New Zealand)
(fax) (64 4) 802 6881

Canada:

Agilent Technologies Canada Inc.
5150 Spectrum Way,
Mississauga, Ontario
L4W 5G1
(tel) 1 877 894 4414

Europe:

Agilent Technologies
Test & Measurement
European Marketing Organisation
P.O. Box 999
1180 AZ Amstelveen
The Netherlands
(tel) (31 20) 547 9999

Latin America:

Agilent Technologies
Latin American Region Headquarters
5200 Blue Lagoon Drive, Suite #950
Miami, Florida 33126
U.S.A.
(tel) (305) 267 4245
(fax) (305) 267 4286

United States:

Agilent Technologies
Test and Measurement Call Center
P.O. Box 4026
Englewood, CO 80155-4026
(tel) 1 800 452 488

In any correspondence or telephone conversations, refer to the power sensor by its model number and full serial number. With this information, the Agilent Technologies representative can quickly determine whether your unit is still within its warranty period.

Returning equipment for repair
Sales and Service Offices

A **Upgrading the HOP Controller ROM and Firmware**

This chapter describes how to upgrade the HOP Controller ROM and firmware on the HP/Agilent 8922 P to allow it to run the HSCSD functionality.

Upgrading the Hop Controller ROM

CAUTION

Perform the following procedures at a static safe workstation. The printed circuit assemblies in the instrument are very sensitive to static electricity.

WARNING

Before disassembling the instrument, turn the line switch OFF and unplug the instrument. Failure to unplug the instrument may result in personal injury.

To upgrade the HOP controller ROM

Before connecting the two HP/Agilent 8922 P systems together to form the HP/Agilent 8922 GSM HSCSD Tests System you must upgrade the Hop Controller ROM on both the master and slave unit as follows:

- Step 1.** Make sure that power to the unit is switched off and the power cord is removed.
- Step 2.** Remove the instrument top cover.
 1. Remove four 2-pt. Pozidriv top bumper mounting screws.
 2. Remove four 2-pt. Pozidriv side mounting screws and bumpers.
 3. Remove four 2-pt. Pozidriv screws and standoffs.
 4. Remove fourteen TX-10 screws and top cover. To remove cover, pull sides slightly apart, slide back a few inches and lift off.

Figure A-1 Removing the top cover

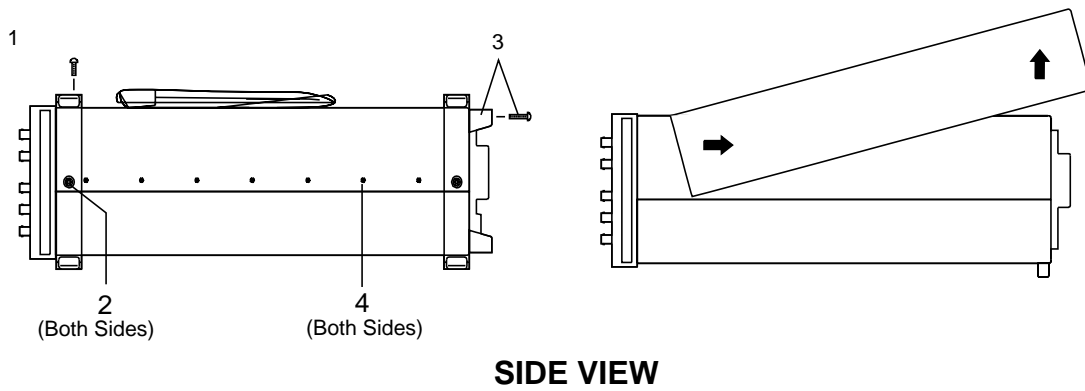

Step 3. Remove RF covers A and B using a TX-15 screw driver (see below).

Figure A-2 Removing the RF covers A and B

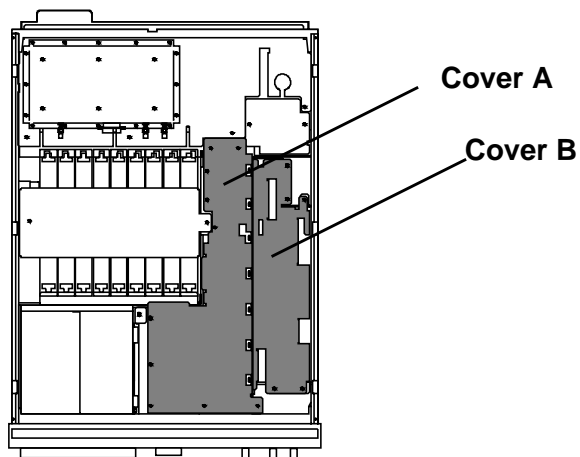

Step 4. Disconnect any necessary cables to free the A33 HOP Controller board.

Step 5. Remove the A33 HOP Controller board.

Upgrading the HOP Controller ROM and Firmware
Upgrading the Hop Controller ROM

Figure A-3 **Removing the A33 Hop Controller Board**

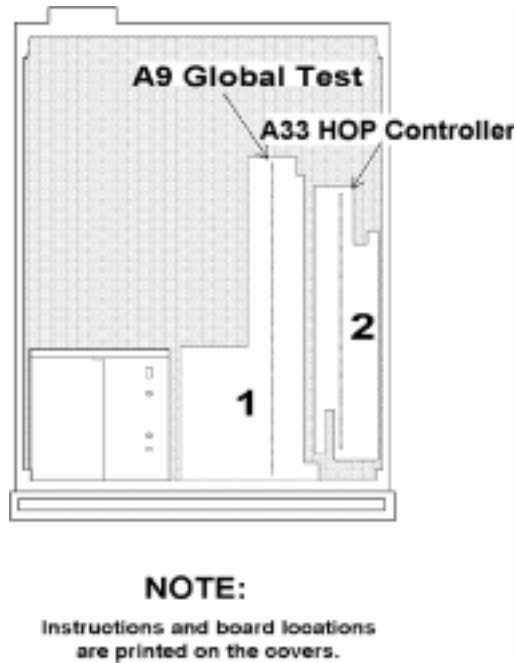

Step 6. Remove the A33 U62 HOP Controller ROM.

You may need to force when removing and replacing the ROM.

Figure A-4 **Removing the A33 U62 HOP Controller ROM**



Step 7. Insert the new A33 U62 HOP Controller ROM making sure that the orientation of the ROM matches the template shown on the board.

Step 8. Reinstall the A33 HOP Controller board.

Step 9. Reconnect the cables.

Step 10. Replace the instrument top cover.

Upgrading the firmware

The HP/Agilent 8922 GSM HSCSD Test System host firmware is downloaded to the instrument over the GPIB interface. This is performed using an external controller with an GPIB interface and the HP BASIC programming language. Contact your local Agilent Technologies Customer Service Center or Representative for more information.